

**PREINSTALLATION  
VORINSTALLATION**

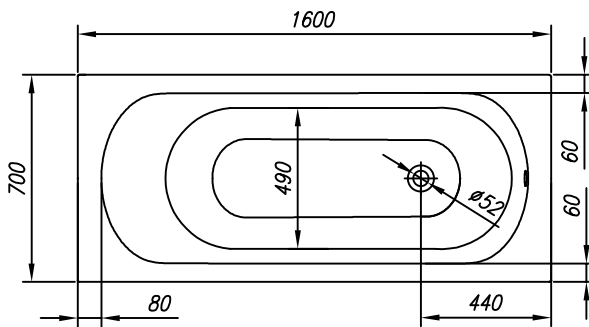
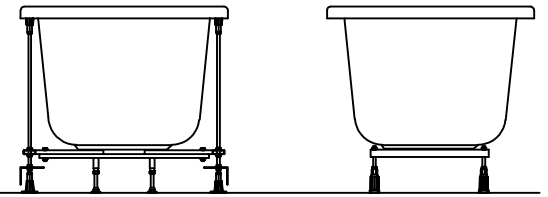
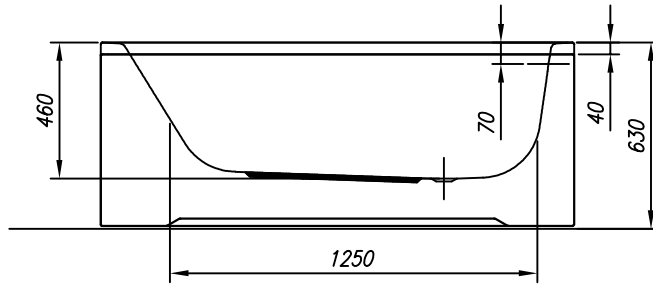

VOLUME (l)  
VOLUMEN (l)

MAX. LOAD (kg)  
MAX. BELASTUNG (kg)

FLOOR LOAD (kg/m<sup>2</sup>)  
BODENBELASTUNG (kg/m<sup>2</sup>)

200

345

310

- - Spot for el. cable 3×2.5mm<sup>2</sup>, length approx. 1m  
- Platz Stromkabel 3 × 2,5 mm<sup>2</sup>, Länge cca. 1 m
- - Spot for el. cable 1×6mm<sup>2</sup> for earthing, length approx. 1.5m  
- Platz Stromkabel 1 × 6 mm<sup>2</sup> für Erdung, Länge cca. 1,5 m
- ⊠ - Connection of hot and cold water 1/2" min 0.2Mpa, max 0.4Mpa  
- Anschluss Warm- und Kaltwasser 1/2" min 0,2 Mpa, max 0,4 Mpa
- - Drain spot Ø 50mm  
- Abflussplatz Ø 50 mm
- ▨ - Panel - option  
- Möglichkeit - Schürze

**INSTALLATION RECOMMENDATION  
MONTAGEEMPFEHLUNG**

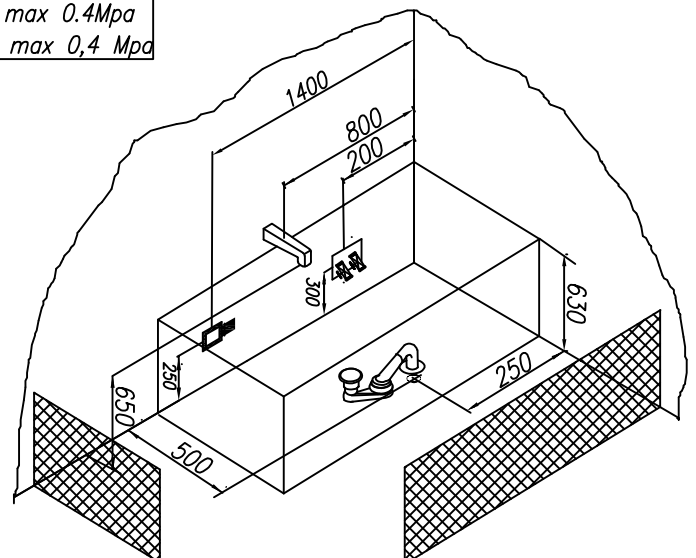

|   |                         |
|---|-------------------------|
| Recommended overflow set<br>Vorgeschlagene Überlaufgarnitur   | PAL 650                 |
| Recommendations for the installation of bathtub without panel<br>Empfehlungen für die Montage von Badewannen ohne Schürze | Nr. MK 03               |
| Recommendations for the installation of bathtub with panel<br>Empfehlungen für die Montage von Badewannen mit Schürze     | Nr. MK 01               |
| Option of the built-in bathtub base<br>Möglichkeit des Sockels für die Badewannen ohne Schürze                            | Nr. MK 05<br>PKK 501    |
| Option of the bathtub base with panel<br>Möglichkeit des Sockels für die Badewannen mit Schürze                           | Nr. MK 12<br>CM 160-170 |

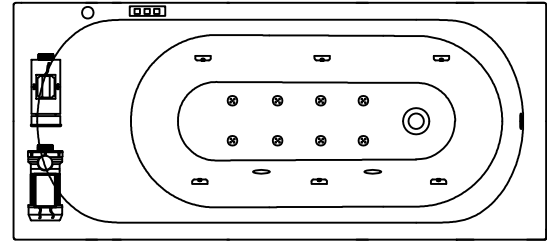
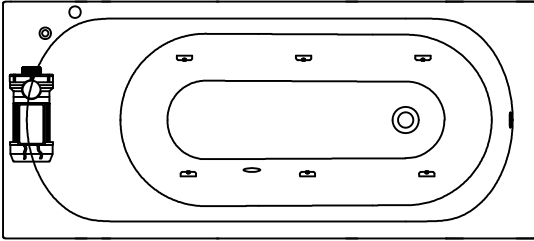
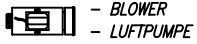
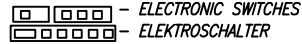
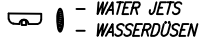
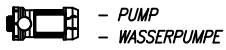

WATER MASSAGE SYSTEM 1 WASSERMASSAGESYSTEM 1

- PUMP P=800W
- PNEUMATIC SWITCH
- AIR CONTROLLER
- 6 WATER JETS
- WASSERPUMPE P = 800 W
- PNEUMATIKSCHALTER
- LUFTREGLER
- 6 WASSERDÜSEN

WATER AND AIR MASSAGE SYSTEM

- PUMP P=800W
- BLOWER P=800W
- ELECTRONIC SWITCH
- 6 SUPER WATER JETS
- 8 AIR JETS
- AIR REGULATOR

WASSER UND LUFT MASSAGESYSTEM

- WASSERPUMPE P = 800 W
- LUFTPUMPE P = 800 W
- ELEKTROSCHALTER
- 6 SUPER-WASSERDÜSEN
- 8 LUFTDÜSEN
- LUFTREGLER

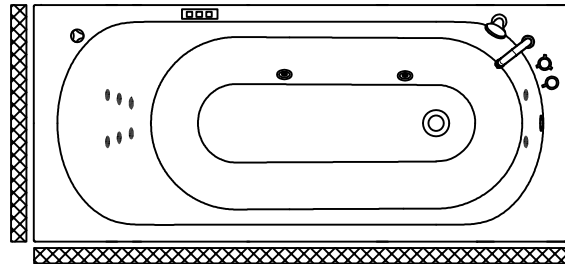

- OPTION FIXTURE AND SHOWER HANDLE - MÖGLICHKEIT WASSERHAHN UND DUSCHE

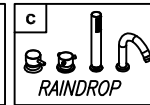
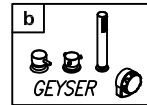

- OPTION 6 MICROJETS P=1250W - MÖGLICHKEIT MIKRODÜSEN 6 P = 1250 W



- OPTION CHROMOTHERAPY - MÖGLICHKEIT CHROMOTHERAPIE



- OPTION PANEL FOR BATHTUB - OPTION SHÜRZE FÜR BADEWANNE

