

PREDINSTALACIJA
PREDINSTALACIJA

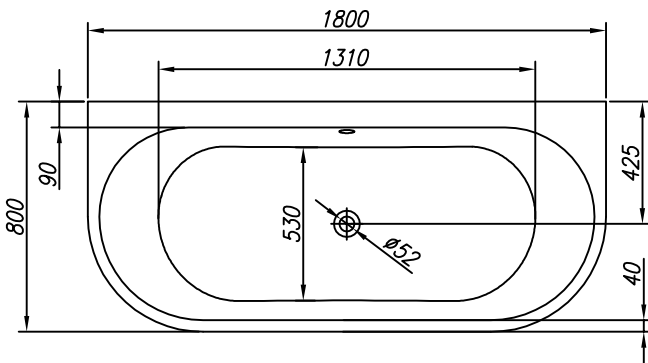

VOLUMEN (l)
VOLUMEN (l)

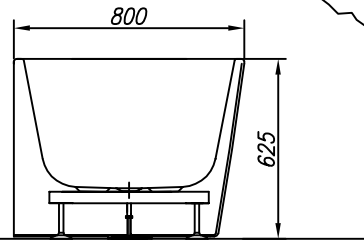

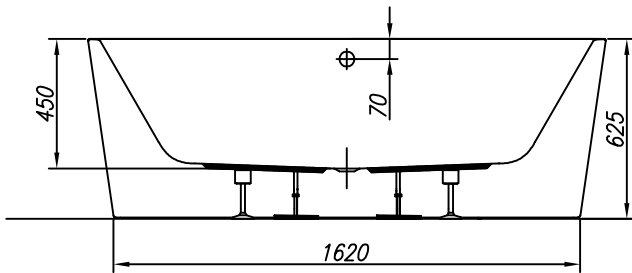
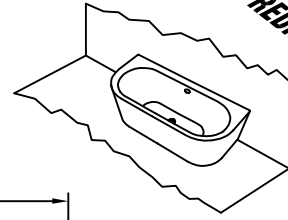

MAX. OBREMENITEV (Kg)
MAX. OBTEREČENJE (Kg)



OBREMENITEV TAL (Kg/m²)
OBTEREČENJE PODA (Kg/m²)



245

420

310

-  - Prostor za el. vodnik 3 x 2,5 mm², dolžine cca 1m.
-  - Mjesto za el. vodnik 3 x 2,5 mm², dužine cca 1m.
-  - Prostor za el. vodnik 1 x 6 mm² za ozemljitev, dolžine cca 1,5m.
-  - Mjesto za el. vodnik 1 x 6 mm² za ozemljenje, dužine cca 1,5m.

-  - Priklop tople in hladne vode 1/2" min 0,2 Mpa, max 0,4 Mpa
-  - Priključak tople i hladne vode 1/2" min 0,2 Mpa, max 0,4 Mpa

-  - Prostor za odtok ø 50 mm
-  - Mjesto za odtok ø 50 mm

PREDLOG VGRADNJE
PRIJEDLOG UGRADNJE

