

VOLUMEN (l)
VOLUMEN (l)









MAX. OBREMENITEV (kg)
MAX. OBTEREČENJE (kg)

OBREMENITEV TAL (kg/m²)
OBTEREČENJE PODA (kg/m²)

205

370

310

-  – Prostor za el. vodnik 3 x 2,5 mm², dolžine cca 1m.
-  – Mjesto za el. vodnik 3 x 2,5 mm², dužine cca 1m.
-  – Prostor za el. vodnik 1 x 6 mm² za ozemljitev, dolžine cca 1,5m.
-  – Mjesto za el. vodnik 1 x 6 mm² za ozemljenje, dužine cca 1,5m.
-  – Prostor za odtok \varnothing 50 mm
-  – Mjesto za odtok \varnothing 50 mm
-  – Opcija-obloga
-  – Opcija-obloga

PREDLOG VGRADNJE
PRIJEDLOG UGRADNJE

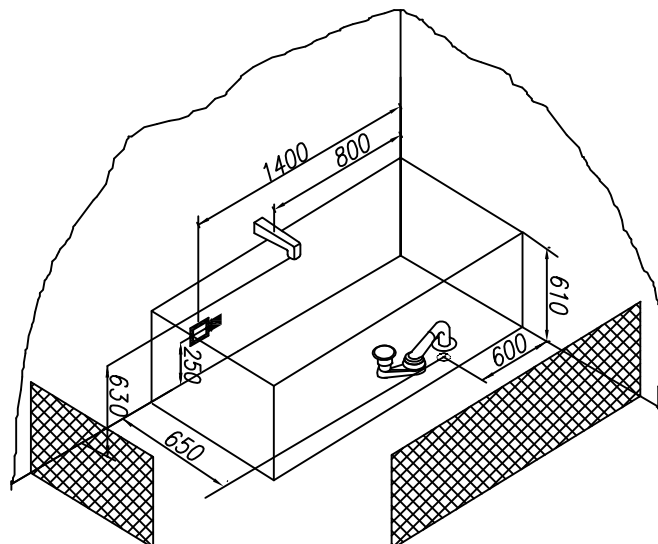

Priporočena prelivna garnitura Preporuka prelivne garniture	PAL 650
Priporočila za vgradnjo kadi brez obloge Preporuka za ugradnjo kade brez obloge	Nr. MK 03
Priporočila za montažo kadi z oblogo Preporuka za ugradnjo kade sa oblogom	Nr. MK 01
Opcija podnožja kadi za vgradnjo Varianta postolja za kade brez obloge	Nr. MK 05 PKK 501
Opcija podnožja kadi z oblogo Varianta postolja za kade sa oblogom	Nr. MK 12 CM 160-170